

PHOTOGRAPHY

LIGHTINGS



A direct flash produced a very hard light, creating deep and defined shadows under his chin and in the background



Much softer and more pleasant light By simply bouncing the on-camera flash on the wall

The Most Common Light Patterns

- split lighting;
- loop lighting;
- butterfly lighting;
- Rembrandt lighting;
- Rim lighting;
- and Silhouette lighting.

Multiple Light Setups

- More subtle and complicated (நுட்பமான மற்றும் சிக்கலான) light patterns are possible with several lights.
- With more than one light, you can also separate your model from the background

- *key light,*
- *fill light,*
- *background light*



Split Lighting





Split Light

Split Lighting Setup

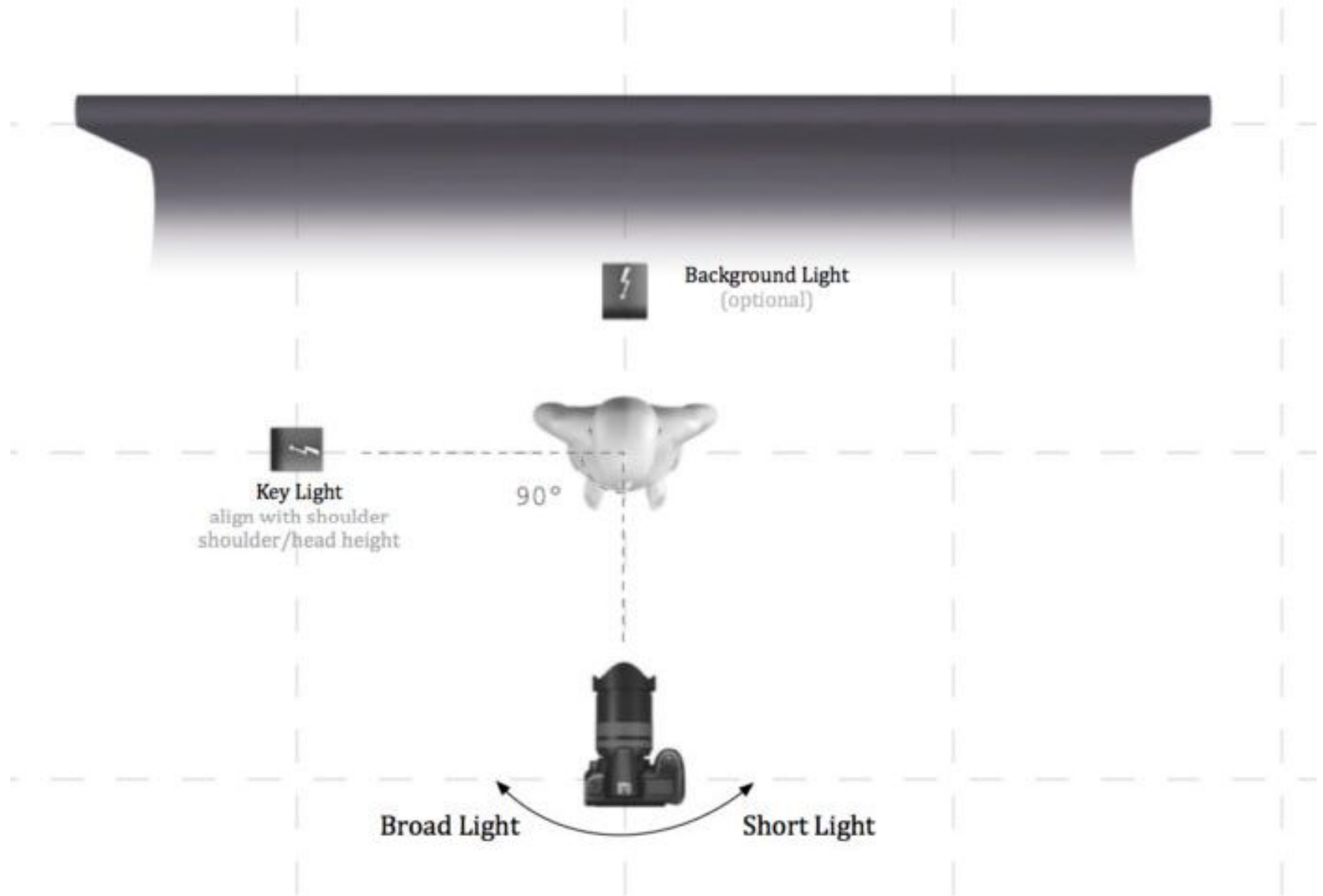

Hero Lighting



- The powerful mood it conveys.
- It produces a strong shadow in the middle of your model's face

Hero Lighting Setup

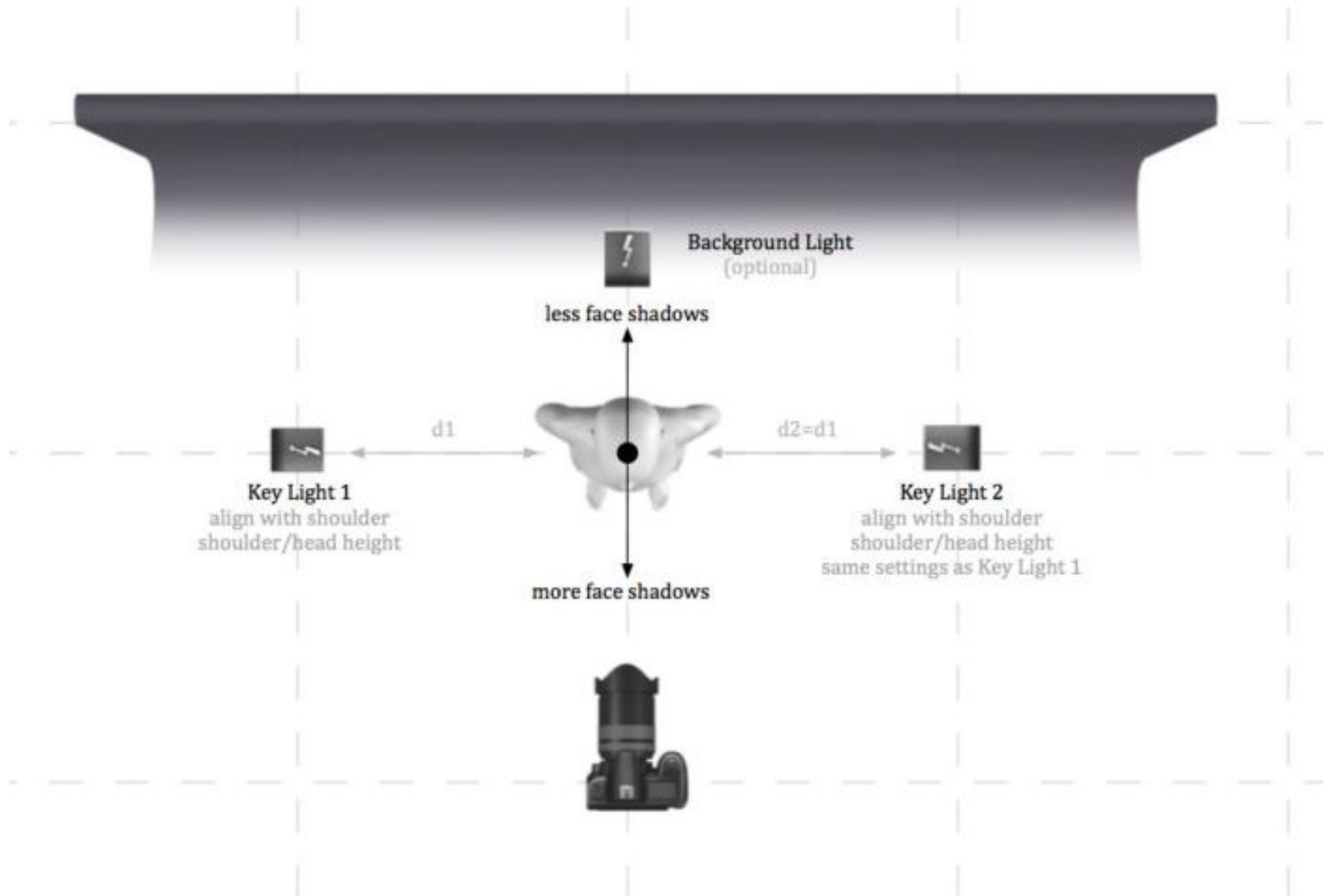

Loop Lighting



The key light covers the unlit side of the nose without extending onto the cheek



?.
?.
?.
?.
?.

?.
?.
?.
?.
?.

PREMIUM

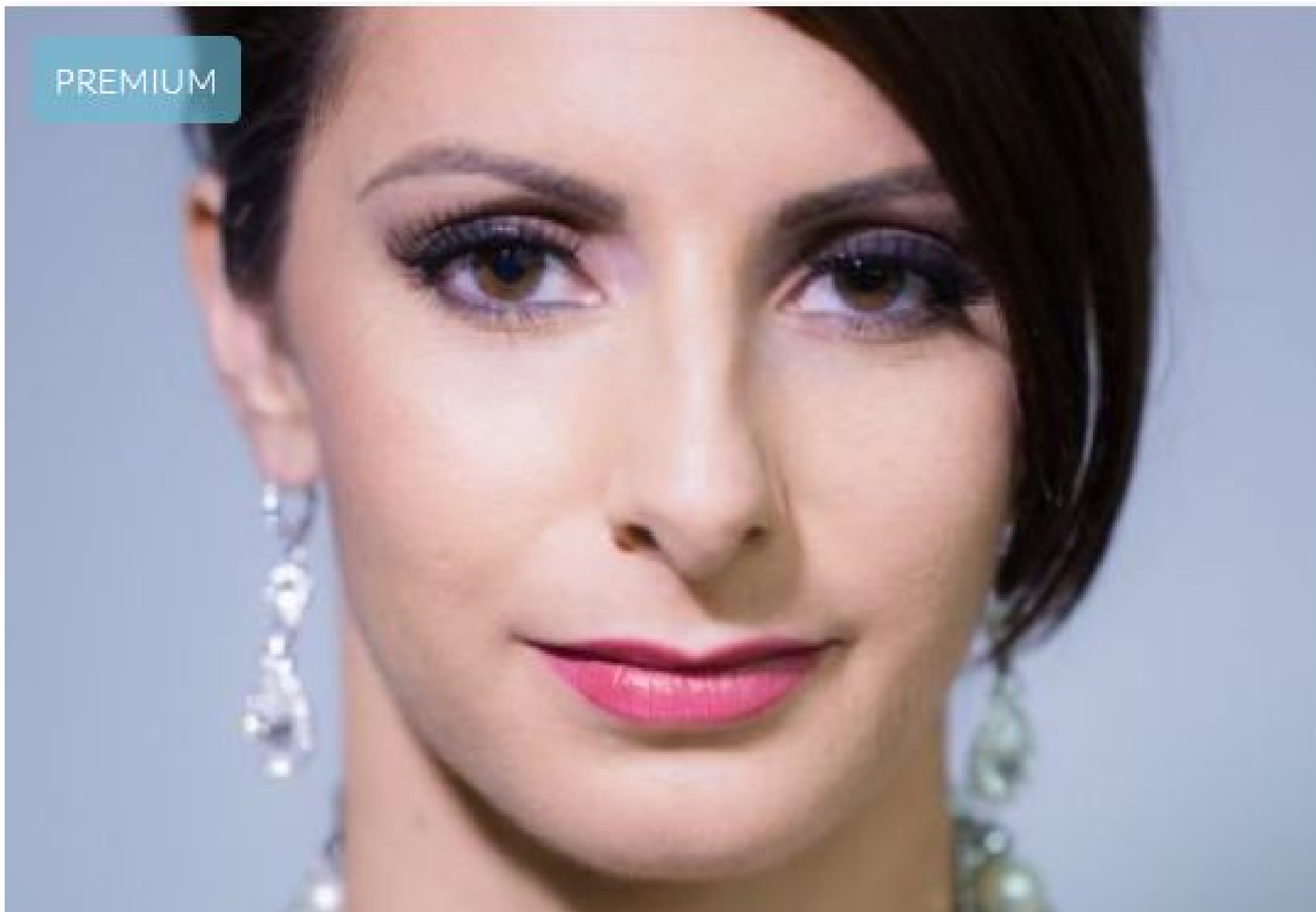

Loop Lighting Setup



Background Light
(optional)



Key Light
above model
about 45° on the side
angled down about 45°



Rembrandt Lighting



Butterfly Lighting



Butterfly Lighting





Butterfly Lighting Setup



Rim Lighting



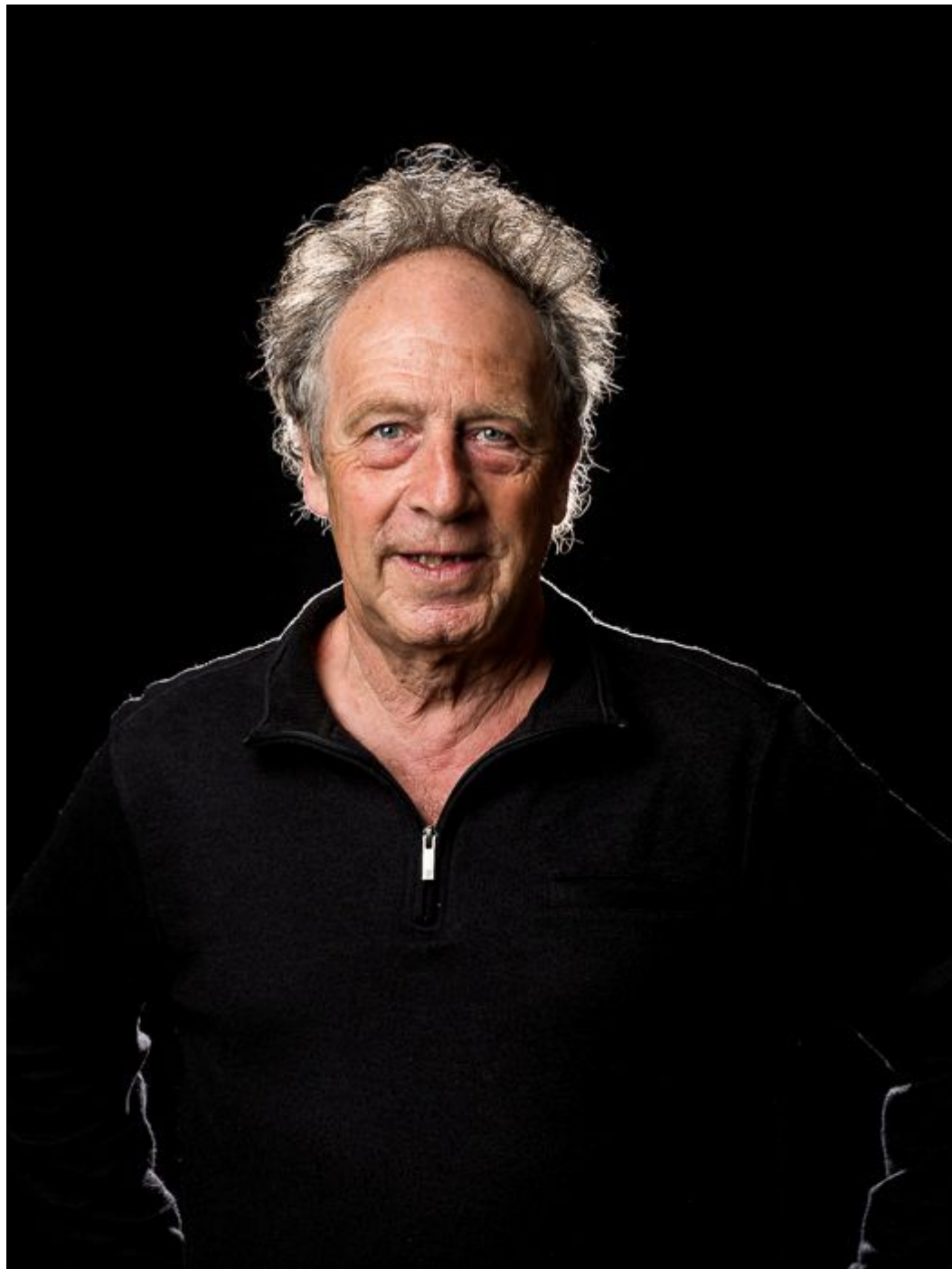

?

?

?

?

?

?

?

?

?

?

?

?

?

?

?

?

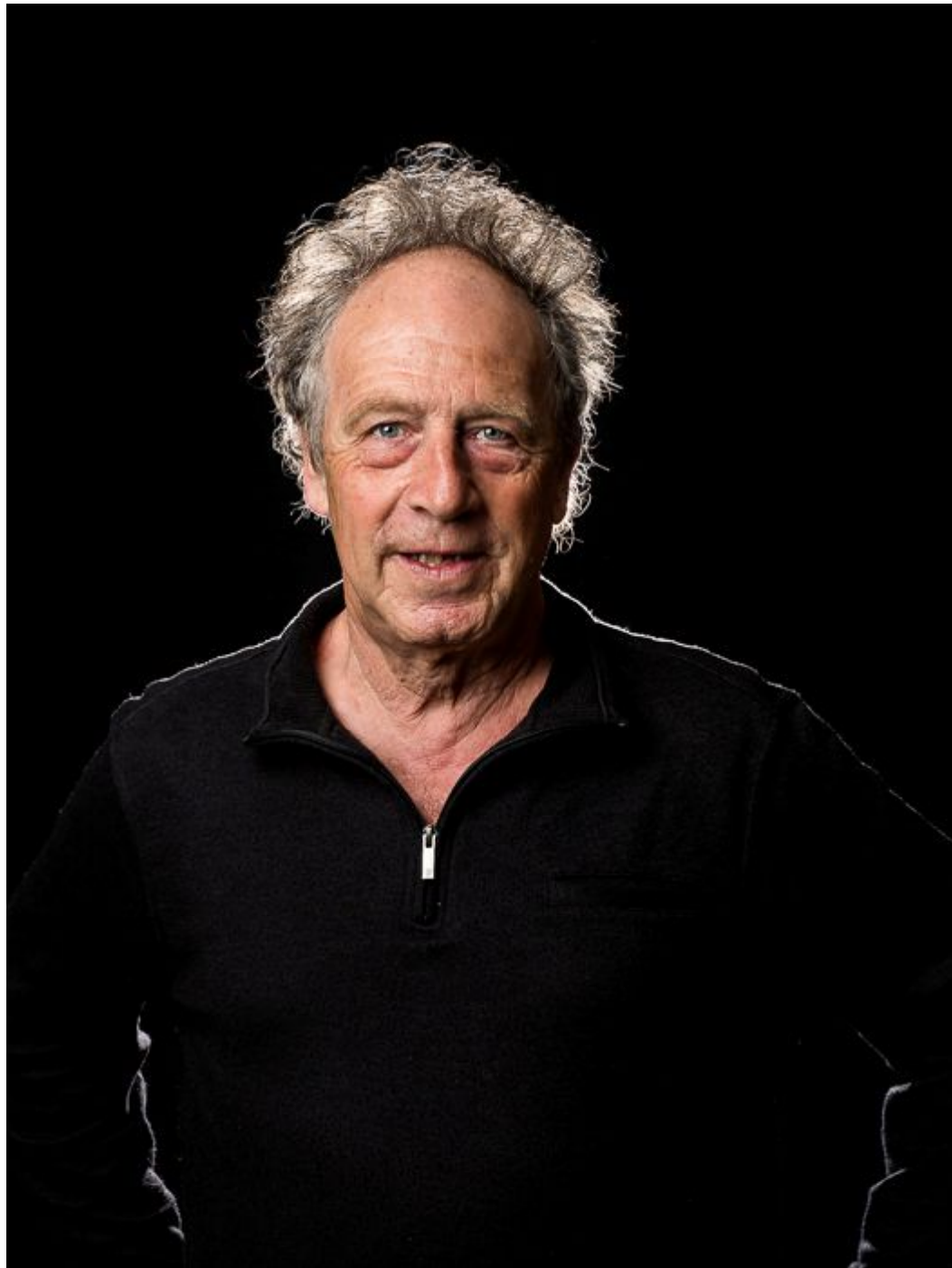
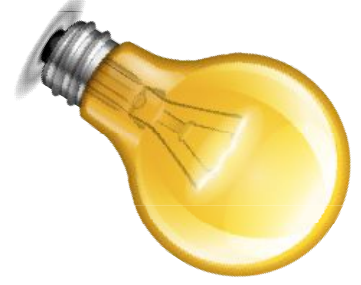

Rim Lighting Setup

1 Rim Light Setup



backlit model



2 Rim Lights Setup



backlit model



Silhouette Lighting







Rafael Lopes » www.flickr.com/bobeirasa

Silhouette Lighting Setup

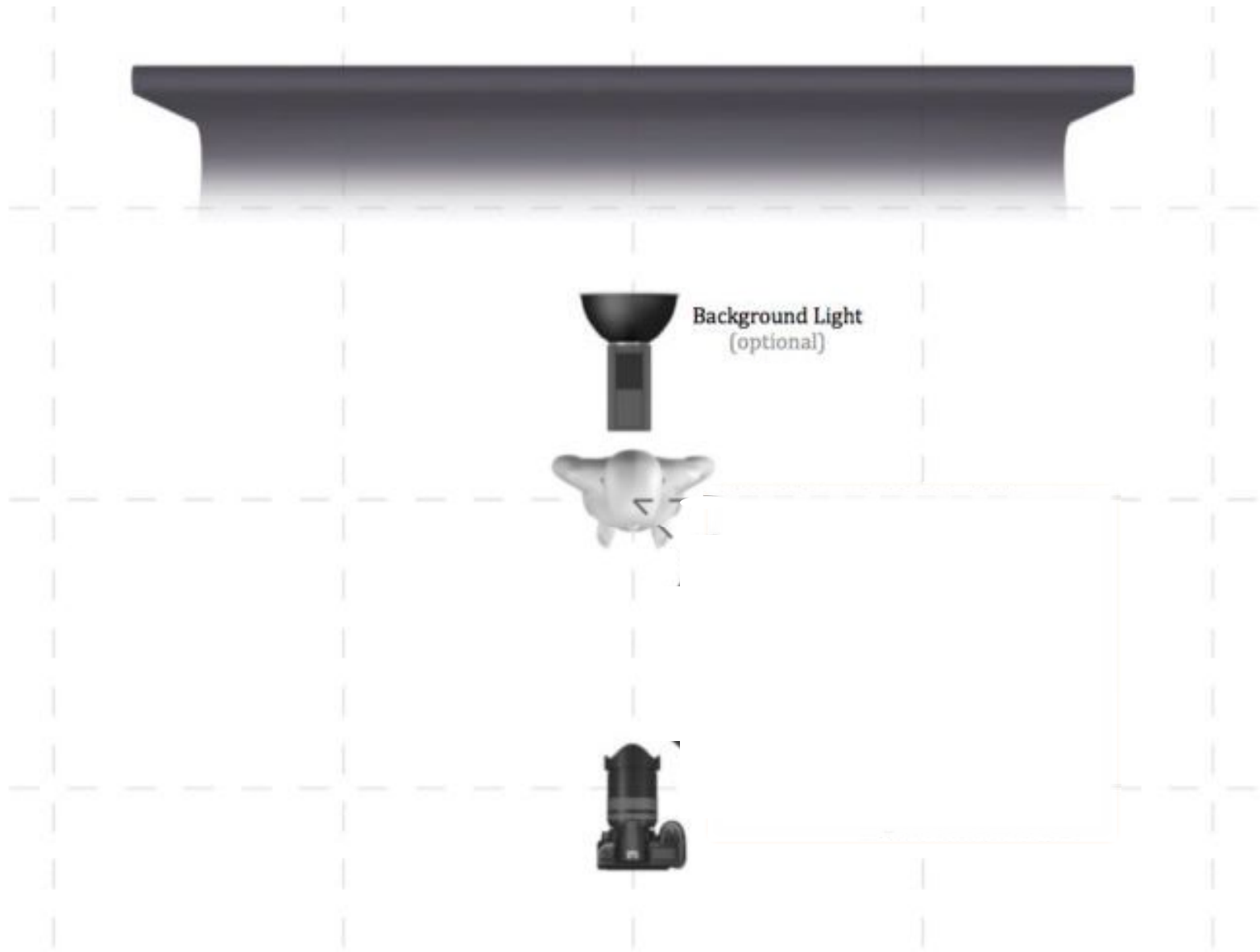

Single Light Setup Cheat sheet

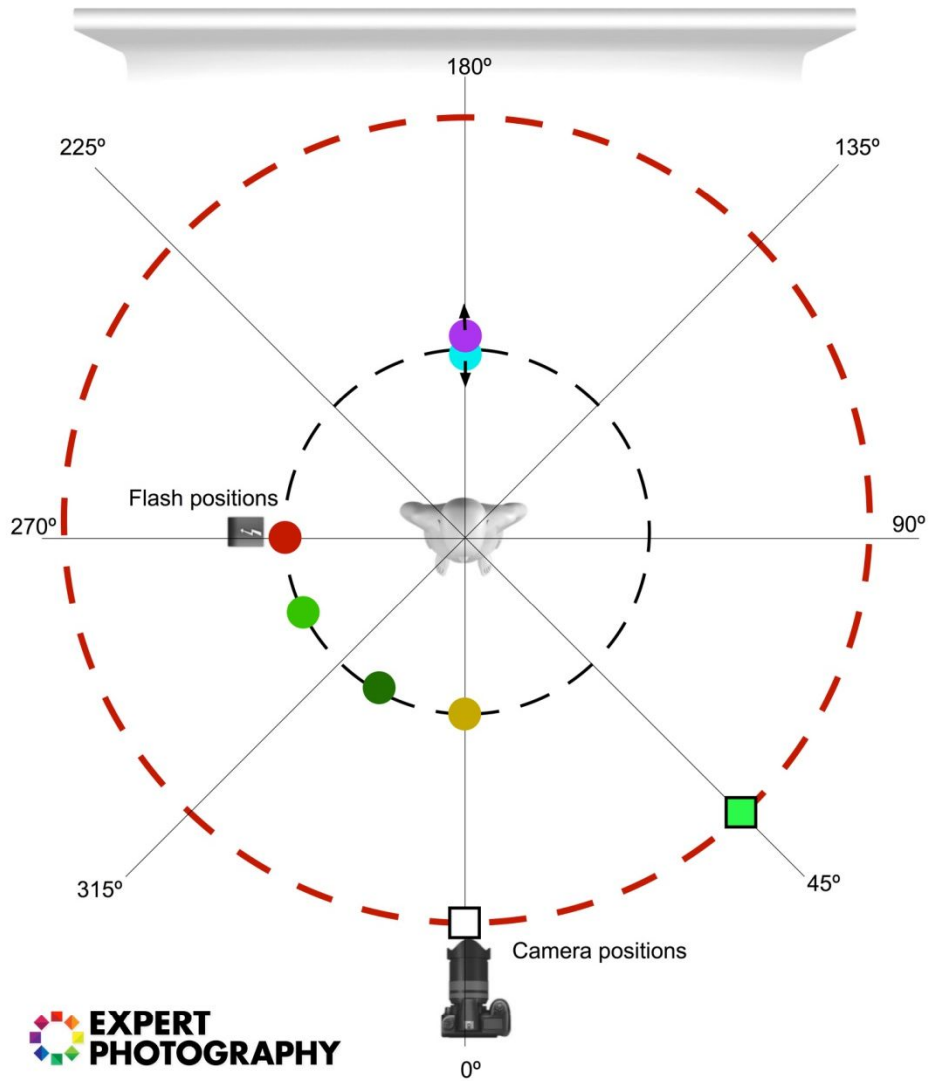

EXPERT PHOTOGRAPHY
 Image credits: Andrea Minoia

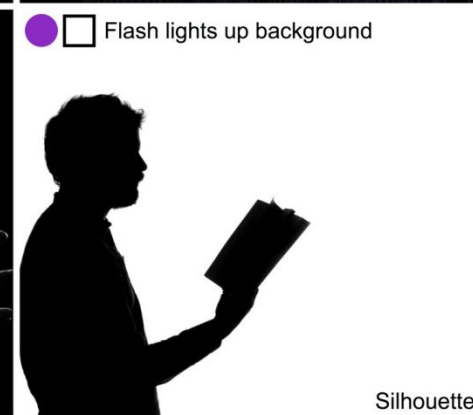

Cyan dot and white square: Flash lights up model

Purple dot and white square: Flash lights up background

SOURCE:

<https://photography.tutsplus.com/tutorials/simple-steps-for-shooting-amazing-silhouettes--photo-2447>

<https://expertphotography.com/must-know-portrait-lighting-patterns-and-tips/>

<https://expertphotography.com/lighting-terms-for-portrait-photography-a-concise-glossary/>